

J1
HDR-M-2.54_1x5

J2
HDR-M-2.54_1x5

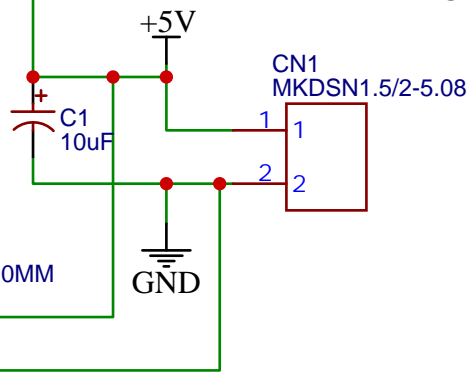
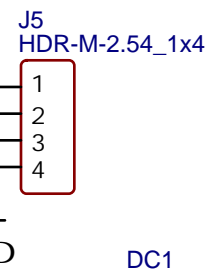
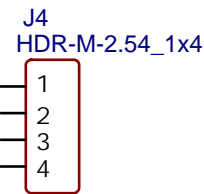
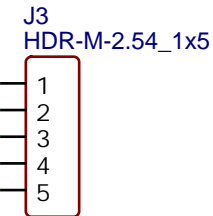
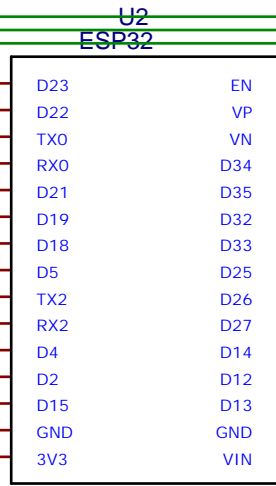
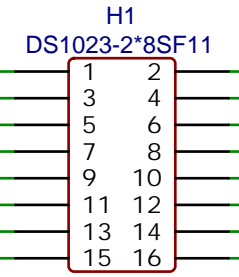
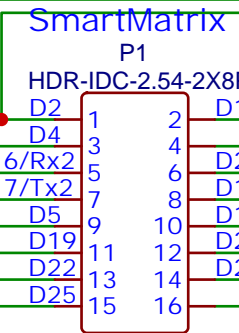
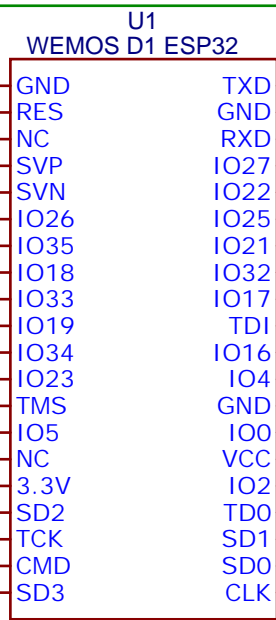

TITLE: Sheet_1		REV: 2.0
EasyEDA	Company: LIGHTWELL Ltd	Sheet: 1/1
	Date: 2021-09-10	Drawn By: fsignbg